

**CONTROL PANEL**  
(PART No. FK5047-00)

NOTE: ALL ALARM CONTACTS ARE ENERGIZED WHEN IN THE NON-ALARM STATE (FAIL SAFE). ALL ALARM CONTACTS WILL CHANGE STATE WHEN CHARGER IS POWERED DOWN. CONTACT RATING IS 0.5A @ 125VAC/VDC RESISTIVE.

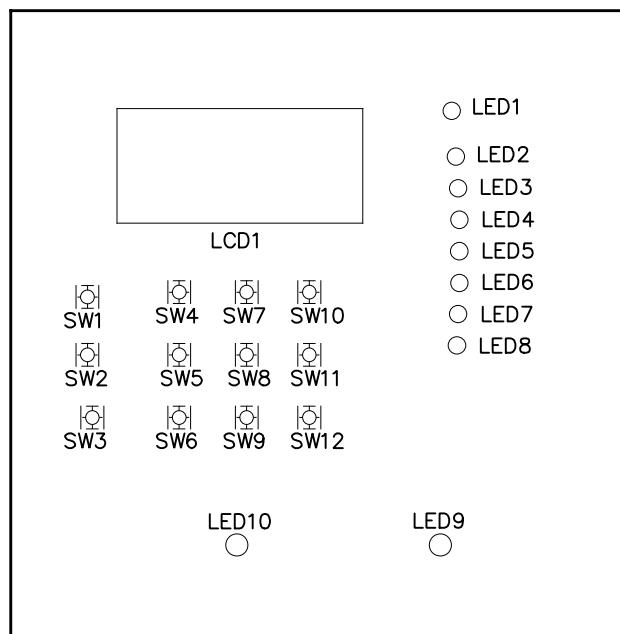

**MAIN CONTROL PC BOARD (A1)**  
FRONT VIEW – FACING CHARGER DOOR WHEN INSTALLED

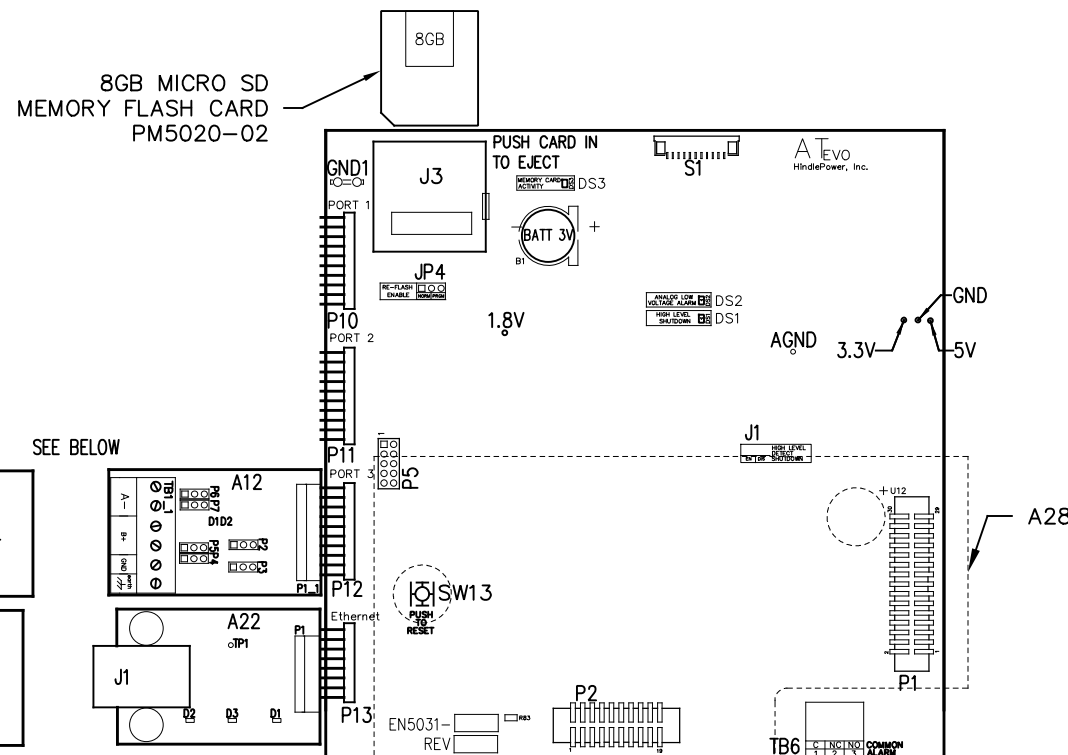

**MAIN CONTROL PC BOARD (A1)**  
BACK VIEW – FACING CHARGER COMPONENTS WHEN INSTALLED

**SERIAL COMMUNICATION ADAPTER (A12)**

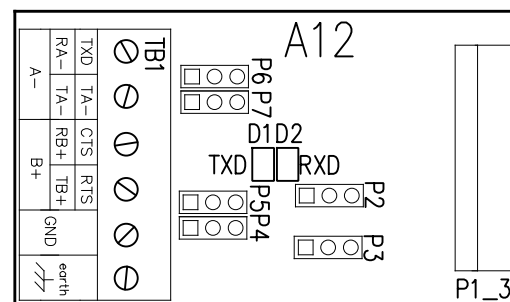

**CONNECTORS (A12):**  
P1 – MAIN CONTROL BOARD

**JUMPERS & CONFIGURATION SWITCHES (A12):**  
P2 – RECEIVER ENABLE CONTROL SELECTION  
P3 – MEDIA CONTROL SELECTION (RS-234 OR RS-485)  
P4 – RS-485 TERMINATION RESISTOR ENABLE (RECEIVE)  
P5 – RS-485 TERMINATION RESISTOR ENABLE (TRANSMIT)  
P6 – RS-485 INTERFACE 2 WIRE/4 WIRE SELECTION (A)  
P7 – RS-485 INTERFACE 2 WIRE/4 WIRE SELECTION (B)

**TERMINAL BLOCKS (A12):**  
TB1 – USER CONNECTIONS TO SERIAL INTERFACE

**INDICATOR LIGHTS (A12):**  
TXD (D1) – SERIAL DATA BEING SENT  
RXD (D2) – SERIAL DATA BEING RECEIVED

**ETHERNET ADAPTER (A22)**

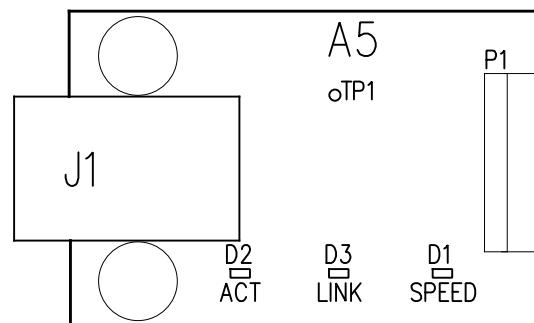

**CONNECTORS (A5):**  
P1 – MAIN CONTROL BOARD  
J1 – RJ-45 ETHERNET USER CONNECTION

**INDICATOR LIGHTS (A5 LEDs):**  
D1 – ORANGE – ETHERNET SPEED INDICATION 10/100 MBPS  
D2 – YELLOW – ETHERNET ACTIVITY (FLASHING)  
D3 – RED – ETHERNET LINK

**TEST POINTS (A5):**  
TP1 – CLOCK OUT

**AC METER MODULE PC BOARD (A28)**  
MOUNTED ON MAIN CONTROL PC BOARD

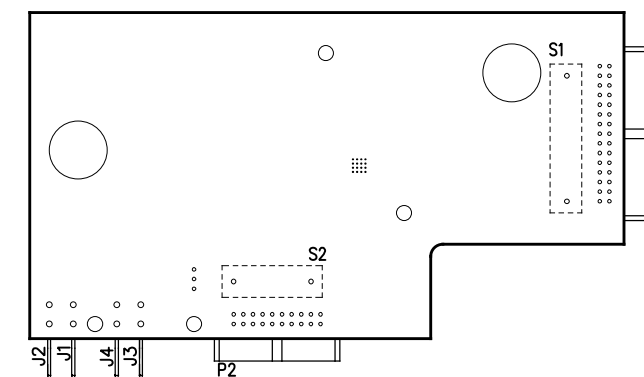

I/O TERMINAL	DESCRIPTION – TYPE	CONNECTION
(A1) TB6	SUMMARY ALARM TERMINAL BLOCK (A1) – SOLDERLESS COMP SCREW	#22-14 AWG
(A12) TB1	RS-232 / RS-485 USER CONNECTIONS – SOLDERLESS COMP SCREW	#22-14 AWG
(A22) J1	SERIAL ETHERNET CONNECTION – RJ45 PLUG	CAT5

**MAIN CONTROL PC BOARD (A1)**

<p><b>INDICATOR LIGHTS (LEDs):</b> LED1 – GREEN – AC ON LED2 – RED – HIGH DC VOLTAGE ALARM LED3 – RED – LOW DC VOLTAGE ALARM LED4 – RED – DC OUTPUT FAILURE ALARM LED5 – RED – AC INPUT FAILURE ALARM LED6 – RED – POSITIVE (+) GROUND ALARM LED7 – RED – NEGATIVE (-) GROUND ALARM LED8 – RED – COMMON ALARM LED9 – RED – ACTION REQUIRED ALARM LED10 – GREEN – HEALTHY OPERATION DS1 – RED – HIGH LEVEL SHUTDOWN (HLD) DS2 – RED – ANALOG LOW VOLTAGE ALARM (LLD) DS3 – RED – MEMORY CARD ACTIVITY</p>	<p><b>JUMPERS:</b> J1 – ANALOG HIGH VOLTAGE SHUTDOWN JUMPER J3 – SD CARD PORT JP4 – RE-FLASH (FIELD PROGRAMMING) JUMPER</p> <p><b>TERMINAL BLOCKS:</b> TB6 – COMMON ALARM RELAY CONTACTS</p> <p><b>TEST POINTS:</b> 1.8V – 1.8 VOLTS 3.3V – 3.3 VOLTS 5V – 5.0 VOLTS GND – GROUND AGND – ANALOG GROUND SDA – MAIN BOARD 12C DATA SCL – MAIN BOARD 12C CLOCK</p>	<p><b>SWITCHES:</b> S1 – DISPLAY BUTTON S2 – CHARGE MODE BUTTON S3 – EQUALIZE METHOD BUTTON S4 – ESCAPE (ESC) BUTTON S5 – LEFT ARROW BUTTON S6 – MENU BUTTON S7 – UP ARROW BUTTON S8 – EDIT / ENTER BUTTON S9 – DOWN ARROW BUTTON S10 – ALARM BUTTON S11 – RIGHT ARROW BUTTON S12 – HINDLE HEALTH (HHS) BUTTON SW13 – SYSTEM RESET BUTTON (BACK OF BOARD)</p>	<p><b>CONNECTORS:</b> P1 – POWER BOARD RIBBON P2 – 3 PHASE RECTIFIER RIBBON P3 – USB EXPANSION PORT P4 – SPI &amp; I2C EXPANSION PORT #1 P5 – SPI &amp; I2C EXPANSION PORT #2 P6 – DISPLAY SPI PORT P7 – DISPLAY JTAG PORTS P10 – SERIAL INTERFACE PORT #1 P11 – SERIAL INTERFACE PORT #2 P12 – SERIAL INTERFACE PORT #3 P13 – ETHERNET INTERFACE PORT P17 – GENERAL EXPANSION PORT</p>
--	---	---	---

REV. DRN BY B KJB	CHK BY MCR	APP BY MCR	DATE 7/21/2021	DRN BY KJB	DATE 11/15/19
DESCRIPTION STANDARD DRAWINGS.				CHK BY MCR	DATE 11/15/19
PROPERTY AND CONFIDENTIAL NOTICE ANY REPRODUCTION, PARTIAL OR AS A WHOLE OF THIS DOCUMENT WITHOUT THE WRITTEN PERMISSION OF HINDLE POWER, INC IS STRICTLY PROHIBITED.				APP BY MCR	DATE 11/15/19
<p>TITLE <b>ATEVO BATTERY CHARGER CONTROL PANEL / PC BOARD DETAIL WITH COMMON OPTIONS FOR CHARGERS AT 30-50ADC</b></p>				SCALE NTS	DWG No JE5253-29
				REV B	SHEET 1 OF 2

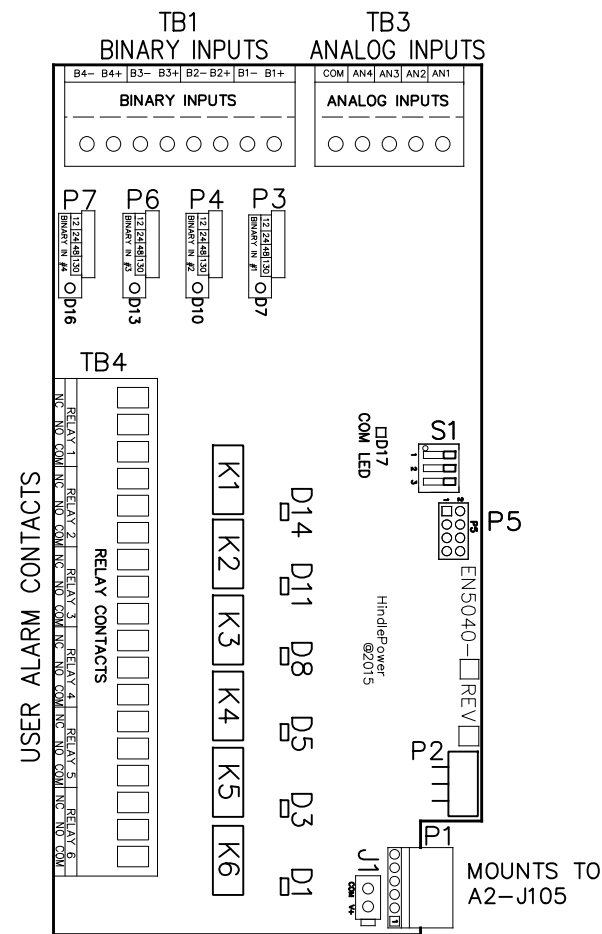

AUXILIARY I/O BOARD (A4)

JUMPERS & CONFIGURATION SWITCHES FOR AUX I/O BOARD (A4)  
 J1 - AUXILIARY POWER INPUT  
 P1 - POWER BOARD (PRIMARY POWER & COMM SOURCE)  
 P5 - PROGRAMMING HEADER

USER TERMINALS ON RELAY BOARD (A4):

- D1 - RED - RELAY #6 IN ALARM STATE
- D3 - RED - RELAY #5 IN ALARM STATE
- D5 - RED - RELAY #4 IN ALARM STATE
- D7 - YELLOW - BINARY INPUT #1 IS ABOVE THRESHOLD
- D8 - RED - RELAY #3 IN ALARM STATE
- D10 - YELLOW - BINARY INPUT #2 IS ABOVE THRESHOLD
- D11 - RED - RELAY #2 IN ALARM STATE
- D13 - YELLOW - BINARY INPUT #3 IS ABOVE THRESHOLD
- D14 - RED - RELAY #1 IN ALARM STATE
- D16 - YELLOW - BINARY INPUT #4 IS ABOVE THRESHOLD
- D17 - GREEN - COMMUNICATION TO MAIN BOARD (FLASHING)

USER TERMINALS ON RELAY BOARD (A4):

- TB1 - BINARY INPUTS
- TB2 - SERIAL INTERFACE
- TB3 - ANALOG INPUTS
- TB4 - AUXILIARY I/O RELAY CONTACTS

JUMPERS & CONFIGURATION SWITCHES

- P3, 4, 6, 7 - BINARY INPUT VOLTAGE CONFIGURATION JUMPERS
- S1 - BOARD ADDRESS DIPSWITCH

FILTER BOARD (A7)

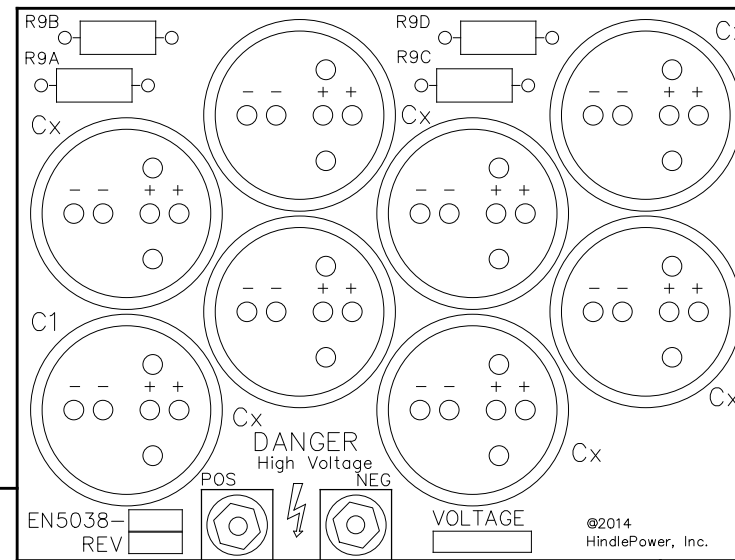

MOUNTS TO A4-P1

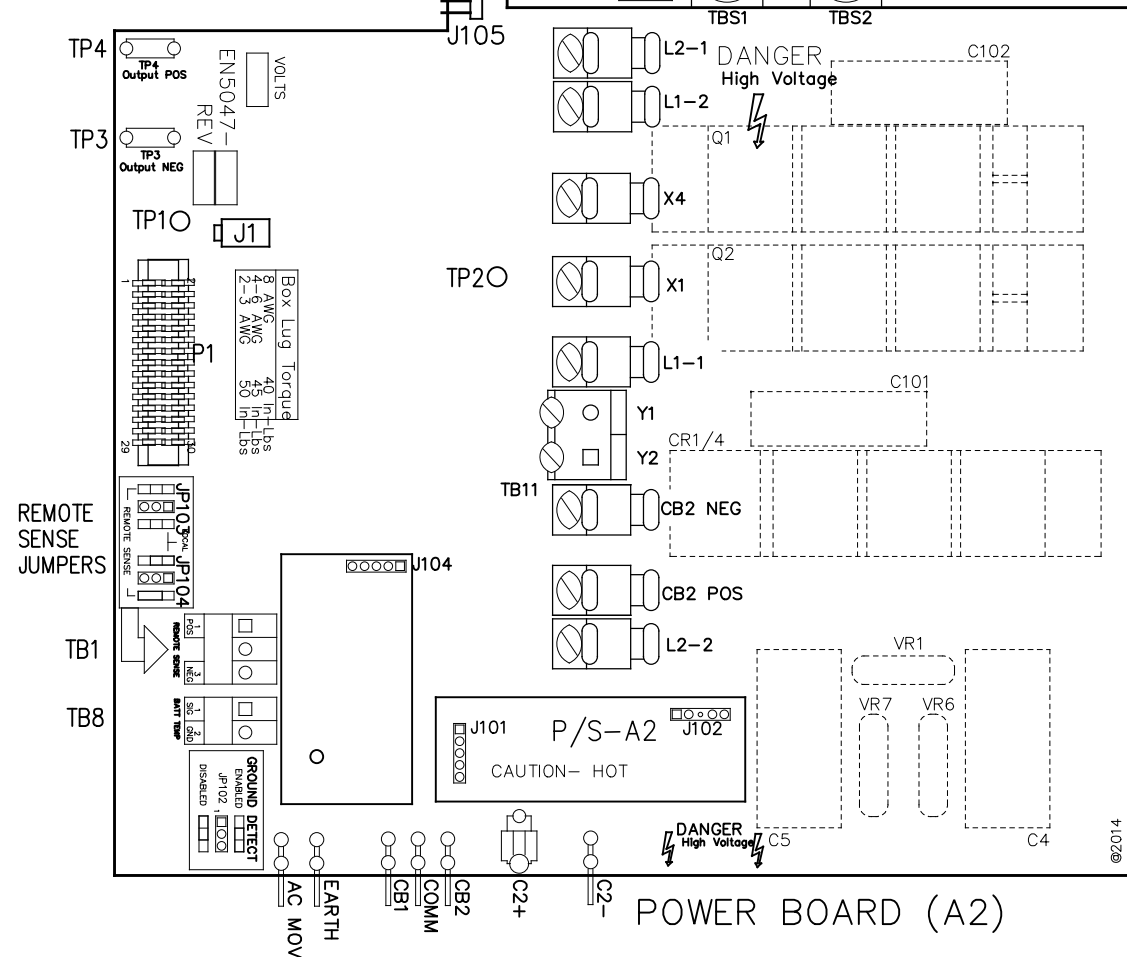

POWER BOARD (A2)

- USER TERMINALS ON POWER BOARD (A2):  
 TB1 - REMOTE VOLTAGE SENSE  
 TB8 - BATTERY TEMPERATURE COMPENSATION
- JUMPERS ON POWER BOARD (A2):  
 JP102 - GROUND DETECT CIRCUIT ENABLE / DISABLE  
 JP103 - REMOTE OR LOCAL SENSE SELECTOR (+)  
 JP104 - REMOTE OR LOCAL SENSE SELECTOR (-)
- CONNECTORS ON POWER BOARD (A2):  
 J1 - POWER OUT  
 J101 - DC POWER SUPPLY  
 J102 - DC POWER SUPPLY  
 J105 - AUXILIARY I/O BOARD  
 P1 - MAIN CONTROL BOARD RIBBON
- DISCRETE TERMINALS:  
 AC MOV - CHASSIS EARTH GROUND  
 EARTH - CHASSIS EARTH GROUND (DOOR)  
 CB1 - AC BREAKER AUX SWITCH CONTACT  
 CB2 - DC BREAKER AUX SWITCH CONTACT  
 COMM - BREAKER AUX SWITCH COMMON  
 C2+ - ELIMINATOR FILTER CAPACITOR (+)  
 C2 - ELIMINATOR FILTER CAPACITOR (-)  
 X1 - TRANSFORMER SECONDARY WINDING  
 X4 - TRANSFORMER SECONDARY WINDING  
 L1-1 - FILTER INDUCTOR #1 (TERMINAL #1)  
 L1-2 - FILTER INDUCTOR #1 (TERMINAL #2)  
 L2-1 - FILTER INDUCTOR #2 (TERMINAL #1)  
 L2-2 - FILTER INDUCTOR #2 (TERMINAL #2)  
 TB10 - CB2 DC BREAKER  
 TB11 - 'Y' CONTROL WINDINGS  
 TBS1 - FILTER CAPACITOR BOARD (+)  
 TBS2 - FILTER CAPACITOR BOARD (-)
- TEST POINTS ON POWER BOARD (A2):  
 TP1 - PRE-FILTERED DC BUS (-)  
 TP2 - PRE-FILTERED DC BUS (+)  
 TP3 - DC BUS (-)  
 TP4 - DC BUS (+)

I/O TERMINAL	DESCRIPTION - TYPE	CONNECTION
(A2) TB1	POS/NEG REMOTE SENSE TERMS (A2) - SOLDERLESS COMP SCREW	#22-14 AWG
(A2) TB8	TEMPCO PROBE (A10) TERM BLK - SOLDERLESS COMP SCREW	#22-14 AWG
(A4) TB1	AUX I/O BINARY INPUTS (A4) - SOLDERLESS COMP SCREW	#22-14 AWG
(A4) TB2	AUX I/O RELAY CONTACTS (A4) - SOLDERLESS COMP SCREW	#22-14 AWG
(A4) TB3	AUX I/O ANALOG INPUTS (A4) - SOLDERLESS COMP SCREW	#22-14 AWG
(A4) TB4	AUX I/O RELAY CONTACTS (A4) - SOLDERLESS COMP SCREW	#22-14 AWG

TITLE			
ATEVO BATTERY CHARGER CONTROL PANEL / PC BOARD DETAIL WITH COMMON OPTIONS FOR CHARGERS AT 30-50ADC			
B	SCALE	DWG No	REV
	NTS	JE5253-29	B
			SHEET
			2 OF 2